

Fixed Bar Grills - G3135

Description

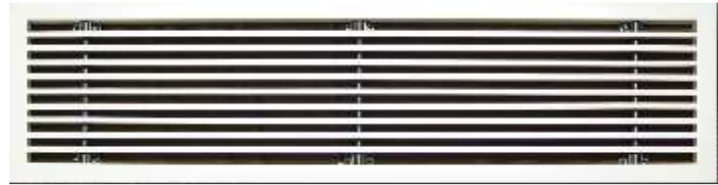

Caryaire Fixed Bar Grills are ideal for Supply as well as Return air, in both Cooling as well as Heating. It can be used in high side wall or ceiling applications. It features 30 degree deflection louvers spaced at 13 mm gaps with 5 mm frontal thickness and with a choice of multiple frames. Optional Opposed Blade Damper can be supplied in Aluminium or Steel construction. Ideal for Continuous lengths with maximum single piece not exceeding 1800mm. Lengths greater than 1800mm are furnished in multiple sections which can be field aligned using the optional alignment strips. All Deflection bars are fixed and are parallel to the Long Dimension. Bars, Frames and Spacer are all Extruded Aluminum.

Available Frames (All Frames are 1mm thick)

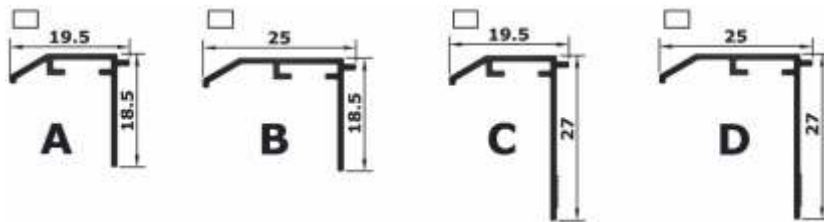

End Borders could be **XX** (All Side Frame) , **XY** (One Side Frame) or **YY** (Open Ends)

Grill thicknesses

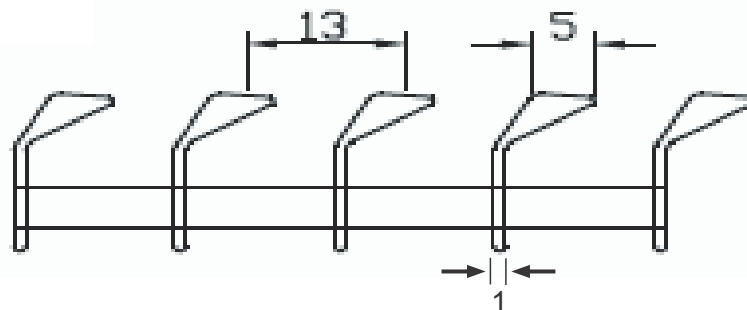

Options :

- 1) Removable core grilles are available as an option. (contains one less louver than fixed core grills)
- 2) Optional Curved Frame grilles are also available.

Product Information

Dimensions *

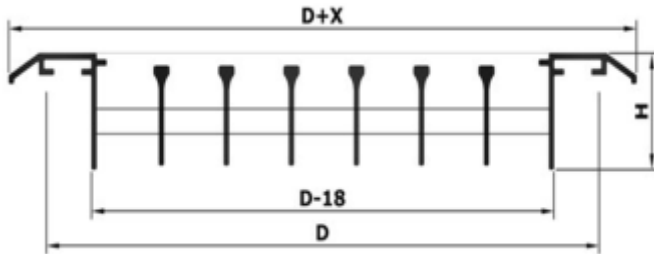

D = Duct Dimension		
	X	H
Frames A	15	18.5
Frames B	26	18.5
Frames C	15	27
Frames D	26	27

Number of Louvers

Nominal Duct Height (mm)	13mm Spacing
75	3
100	5
125	7
150	9
175	11
200	13
225	15
250	17
275	19
300	21

Fastening Method *

F2 – Concealed Mount (Standard)

* Representational drawing only

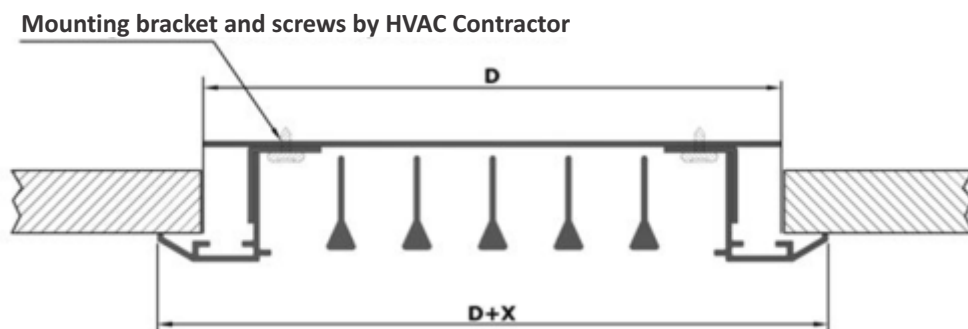

D = Duct Dimension
For Frames A & C : X = 15
For Frames B & D : X = 26

Optional Opposed Blade Volume Control Dampers

Mill Finish Aluminium	Black Finish Aluminium	Black Finish Steel
Model : OBD-AL-MF	Model : OBD-AL-BF	Model : OBD-MS-BL

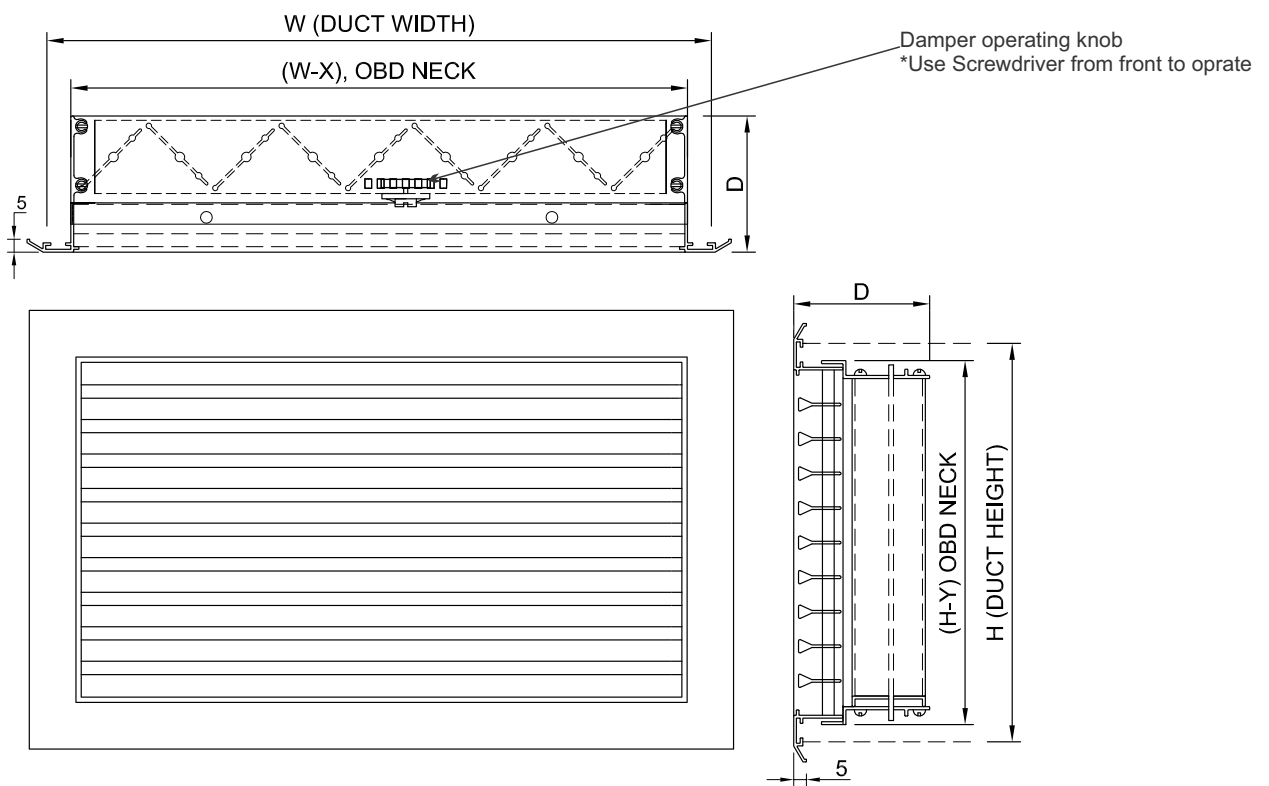

	WITH OBD-AL-MF/BF			WITH OBD-MS-BF		
	D	X	Y	D	X	Y
A/B	52	18±2	12±2	72	14	14
C/D	60			80		

*Note When a Damper is required to be attached to the grill, the grill will be supplied with Frames C or D only

Product Information

Alignment Strips

Alignments Strips are Optional Accessories which can help align two adjacent grill sections for a neat and straight appearance. The strips are made from Steel.

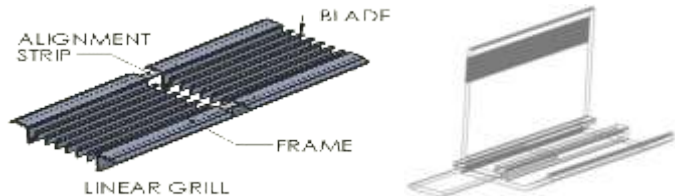

Standard Packaging

Grills are wrapped in Stretch film, usually back to back in pairs and then put into cardboard boxes

Product Labelling

Each Grill will be labeled with dimensions and Caryaire Order #

Standard Colour

Standard shades are Caryaire White (CW) and Caryaire Off White (CO). Other Colour Options (OO) are available at an extra price

Mitered Corners are available

Specifications

Fixed bar grill with parallel bars with 30° deflection, spaced 13mm apart, louver thickness is 5mm at front & 1mm at rear, mounted in a 1mm thick aluminium extruded frame. Fixed bar grills are available in standard one-piece lengths up to 1800mm. Lengths greater than 1800mm are furnished in multiple sections to be joined together end-to-end with optional alignment strips to form a continuous appearance.

The Grill core has extruded aluminum bars fastened into an extruded aluminum border. The deflection bars are fixed and parallel to the long dimension. The core has spacer tubes and shall be parallel to the short dimension. The finish is Epoxy Powder Coated. Extruded aluminum end borders and mitered corners are available to close off the ends of the Grills.

This submittal is meant to demonstrate general dimensions of this product. The drawings are not meant to detail every aspect of the product. Drawings are not to scale.